

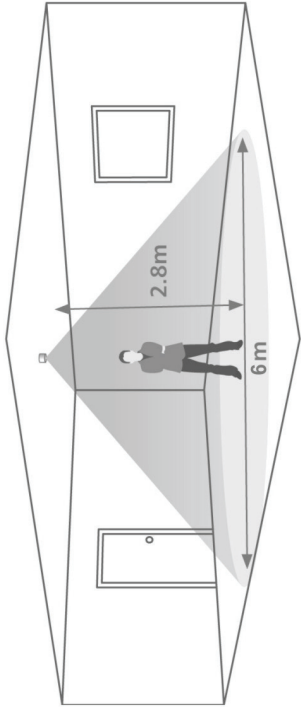

detection pattern



Area of high sensitivity

Area of lower sensitivity



specification

LOAD

- 8 Amp resistive and incandescent lighting
- 4 Amp fluorescent lighting
- 3 Amp compact fluorescent lighting
- 3 Amp low energy lighting
- 3 Amp low voltage lighting (switch primary of transformer)
- 3 Amp fans and ventilation equipment
- Switch SON lighting loads via a contactor

SUPPLY VOLTAGE 220-240 Volts AC 50 Hz
Adjustable 10s to 30m
Light to dark

TERMINAL CAPACITY 2.5 mm²
MATERIAL Flame retardant ABS
TYPE Class 2
TEMPERATURE -10°C to 35°C
CONFORMITY EMC-89/336/EEC
LVD-73/23/EEC

IMPORTANT NOTICE!

This device should be installed by a qualified electrician in accordance with the latest edition of the IEE wiring regulations.



EN55345:20

Due to our policy of continual product improvement CP Electronics reserves the right to alter the specification of this product without prior notice.

Ref #WD297 Issue 2



GEFL Ceiling PIR Presence Detector



dimensions

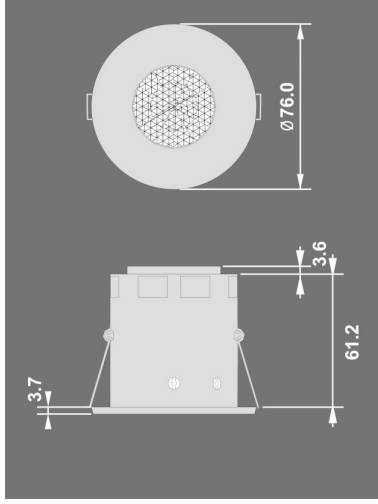

wiring diagram

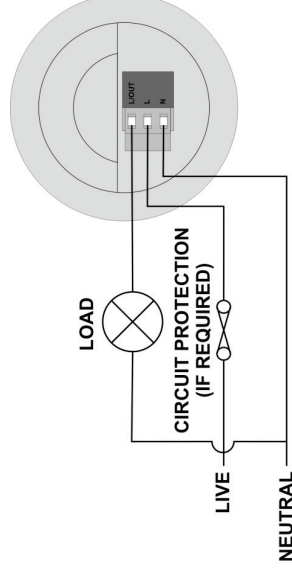

description and operation

The GEFL presence detector is designed to provide automatic control of lighting, heating or ventilation loads. It detects movement using a PIR sensor and turns the load on. When an area is no longer occupied the load will switch off after an adjustable time out period.

An adjustable internal light sensor provides additional energy saving in lighting applications. When an area is occupied lighting is only switched on when the level of natural light is below a preset level.

When the unit is first powered up the PIR sensor will always detect immediately regardless of whether the room is occupied.



mounting

FLUSH FIXING

Warning - be careful bending springs when mounting unit.

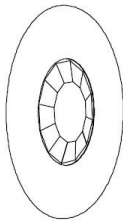

1

Hole Ø64mm

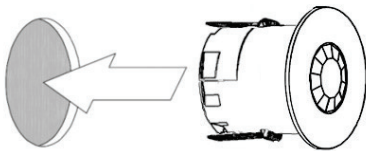

2

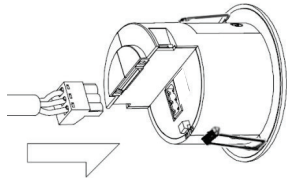

3

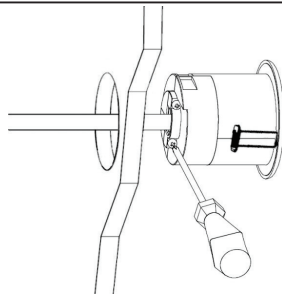

4

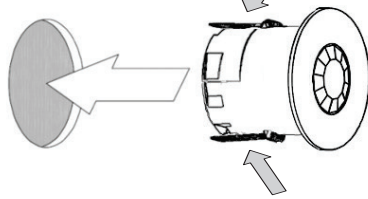

5

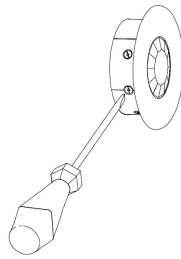

installation

- The detector should be sited so that the occupants of the room fall inside the detection pattern shown overleaf, at a recommended height of 2.8m on the ceiling. Note that the lower the sensor is installed the smaller the detection range will be, subject to the parameters shown on the diagram.
- Avoid direct sunlight entering the sensor.
- Do not site within 1m of forced air heating or ventilation.
- Do not site within 1m of any lighting.
- Do not fix to a vibrating surface.
- Wire the product using the connector using the diagram on the front page.
- Mount using one of the two options above.
- To switch from more than one position simply wire two or more units in parallel.
- Set the LUX level to maximum and the time to minimum.
- Power the unit up—the load should come on immediately.
- Vacate the room or remain very still and wait for the load to switch off (should take no more than 2 minutes).
- Check that the load switches on when movement is detected.
- To set the final LUX level wait until the level of natural daylight is just enough that lighting is required. Starting with the LUX control fully clockwise (at minimum), very slowly turn the control anti-clockwise until the lights come on. Note that when the LUX control is at maximum then the lights will **always** come on with occupancy.
- Set the time required.



fault finding

LOAD DOES NOT COME ON

- Check to see if the live supply to the circuit is good. Strap across the *L* and *LIVE OUT* terminal to turn the load on.
- If the supply and wiring are good, check the LUX level setting. Increase the LUX level setting to allow the controller to turn on at higher ambient natural light level.
- If the detection range is smaller than expected, check the diagram above. Rotating the sensor slightly may improve the range.

LIGHTS DO NOT GO OFF

- Ensure that the area is left unoccupied for longer than the selected timer setting.
- Make sure that the sensor is not adjacent to circulating air, heaters or lamps.